

VISTA FRONTAL

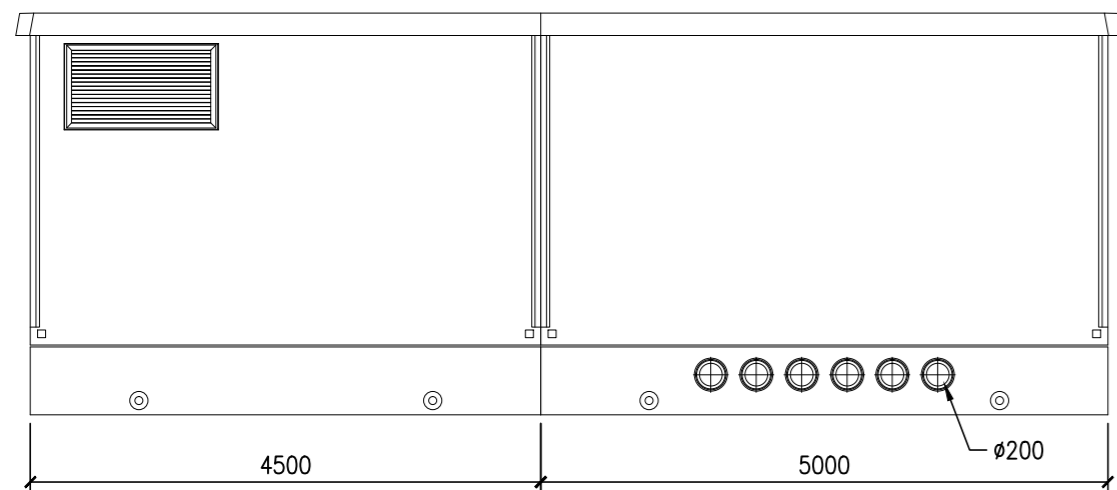

VISTA POSTERIOR

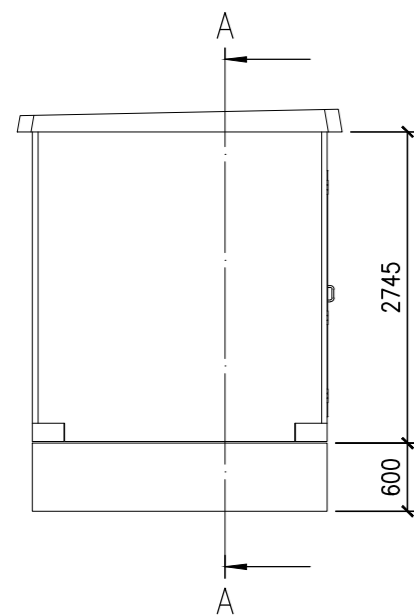

VISTA POR "C"

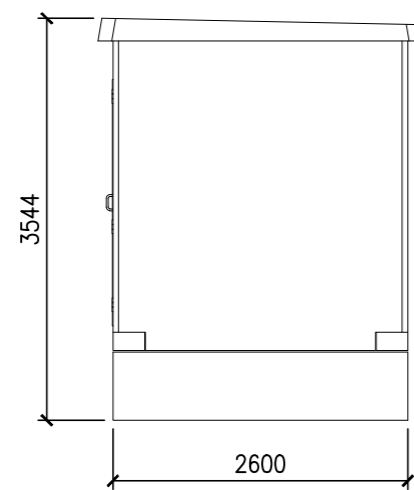

VISTA POR "D"

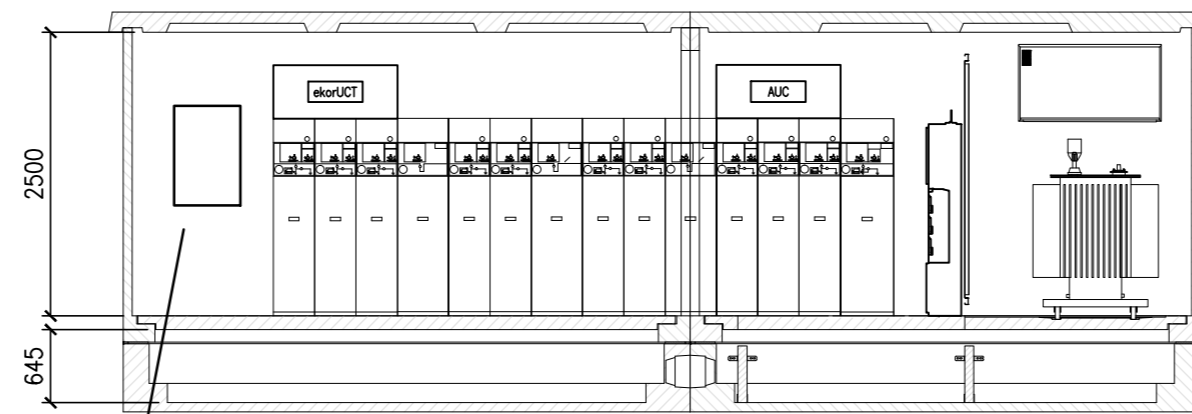

SECCIÓN A-A

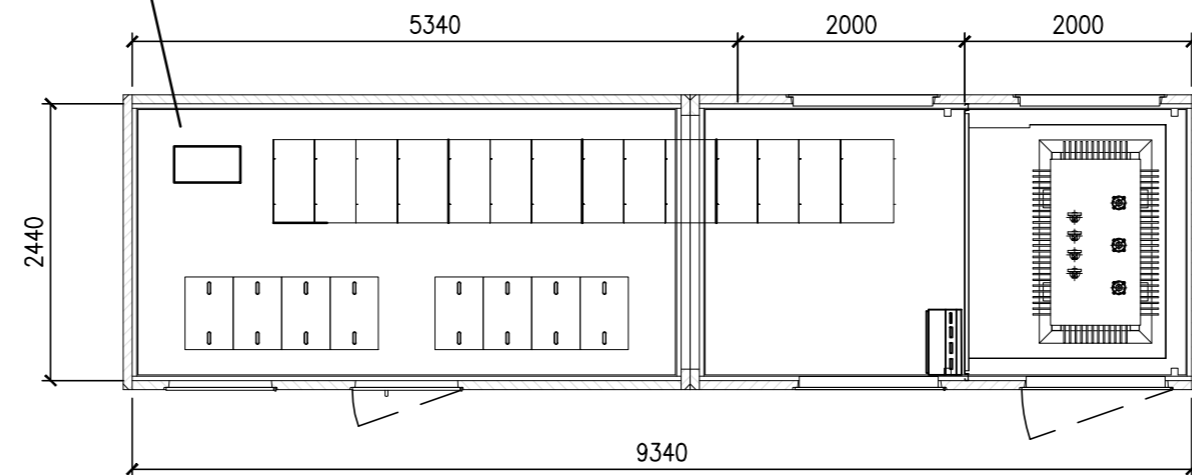

SECCIÓN B-B

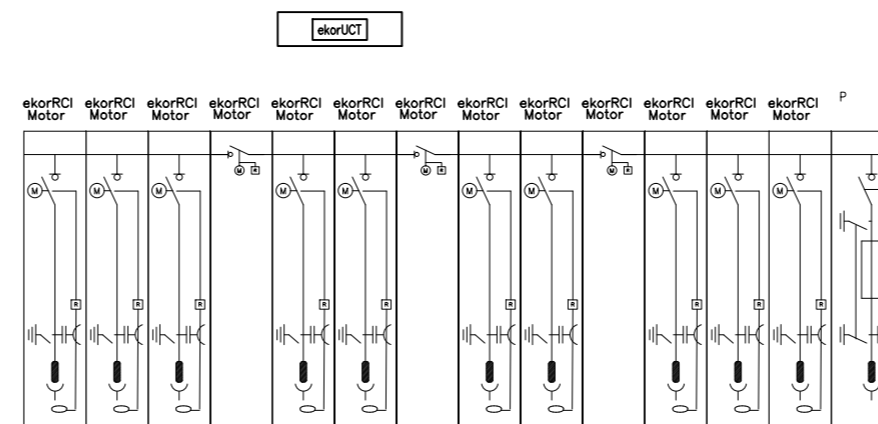

MAGNÍFICO AYUNTAMIENTO DE BURRIANA

Proyecto

GOLF SANT GREGORI

PROYECTO DE URBANIZACIÓN

Mayo de 2020

Plano

**RED DE MEDIA TENSIÓN.
PFU93 10L 3S 1P TELE T400KVA + ATG**

Escala

LA INDICADA

Plano N°

10.4

Hoja

3 de 7

Autores
y directores
del Proyecto



**Octógono
Castellón, S.L.P**

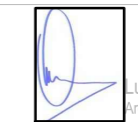

Luis de Marcos Miguel
Arquitecto

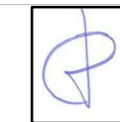

Jesús Delgado Correa
Arquitecto

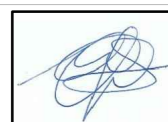

Manuel Gual Valentín
Ingeniero Superior Industrial

Promotor

**URBANIZACIÓN
GOLF SANT GREGORI S.A.U.**